

GEEK Snout

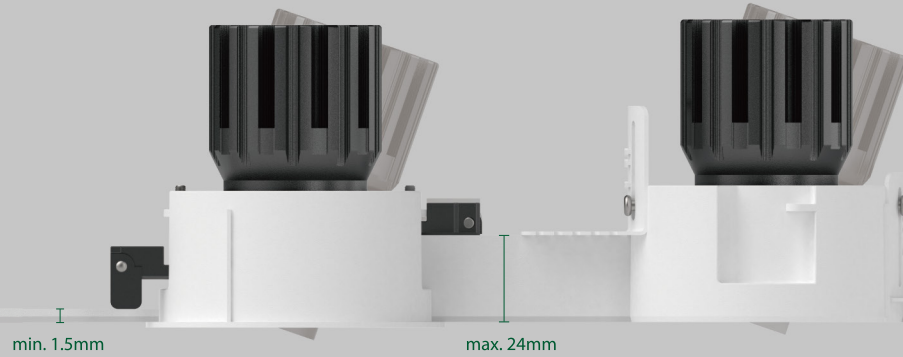

GK75-R05QS

GK75-R05QT



min. 1.5mm

max. 24mm

With Trim

Trimless

White

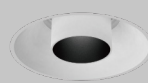
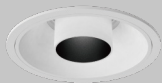

Black

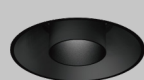

Golden

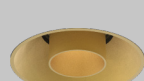
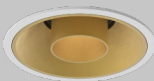

GK75-R05QS

20°/360°



82mm
3.23"

31mm
1.22"

81mm
3.19"

GK75-R05QT

20°/360°

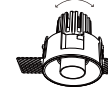

82mm
3.23"

31mm
1.22"

74mm
2.91"

Basic Information

Model	GK75-R05QS/R05QT
Embedded Parts	With Trim/Trimless
Mounting	Recessed
Trim Finishing Color	White/Black
Reflector Color	White/Black/Golden
Material	Cold Forged Pure Alu. (Heat Sink)/Die-casting Alu.
Cutout Size	∅ 75mm
Light Direction	↓ 20° ⇄ 360°
IP Rating	IP20
Power	Max. 15W
Input Voltage	DC36V
Input Current	Max. 350mA

Optical Parameters

Light Source	LED COB
Lumens	65lm/W 90lm/W
CRI	97Ra / 90Ra
CCT	3000K ● 3500K ● 4000K ○
CCT Changeable	2700K — 6000K 1800K — 3000K
Beam Angle	15° 25° 35°
Shielding Angle	67°
UGR	< 9
LED Lifespan	50000hrs

Driver Voltage	AC100-120V AC220-240V
Driver Options	ON/OFF DIM TRIAC/ PHASE-CUT DIM 0/1-10V DIM DALI